

BIC 90 A DATASHEET

RECESSED APPLICATION

LED | 230V/50Hz | IP20



PRODUCT DESCRIPTION

Asymmetrical LED luminaire for recessed application, with trim.
Epoxy polyester lacquered aluminum body.

LIGHT SOURCE

GU10 Lamp
or
COB LED
Driver LED, 220-240VAC-50/60Hz.
CRI>90, 35.000h of useful life.

AVAILABLE COLOR/FINISH



1-white/ 2-black/ 4-anthracite/ 6-grey

AVAILABLE LIGHT TEMPERATURE/ COLOR



2700K/ 3000K/ 4000K

AVAILABLE DIFFUSER



X- without diffuser / O -opaline / T -transparent

AVAILABLE DRIVER

X- Without driver
1- HF - ON/OFF
2- DALI - Flow regulation
3- 1-10V - Flow regulation

STANDARTS: EN 60598-1, EN 60598-2-1



TECHNICAL DRAWING

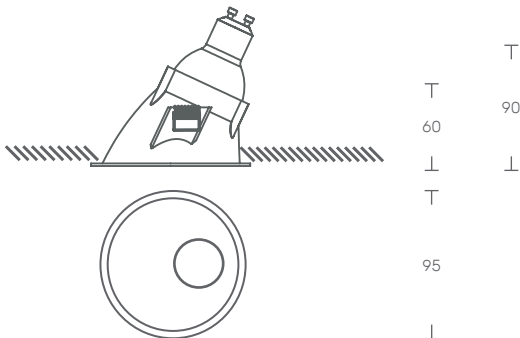

BIC 90 A - LED GU10

LED GU10	POWER (w)	FLOW (lm)	CODE
	6	600	BIC90A.006.LK.AED
	8	825	BIC90A.008.LK.AED
	-	-	BIC90A.000.LK.AED

BIC 90 A - COB LED

	9	700	BIC90A.009.LK.AED
	12	1200	BIC90A.012.LK.AED